



Troubleshooting and Repair Manual

ISB, ISBe4, QSB4.5, QSB5.9, QSB6.7, ISC, QSC8.3, ISL, ISLe3 and QSL9 Engines, CM850 Electronic Control System

Volume 1

SYMPTOM: COOLANT TEMPERATURE ABOVE NORMAL

Cause

- Low Coolant Level
- Collapsed Radiator Hose
- Engine Lubricating Oil Level is too High or Low
- Engine is Receiving too Much Fuel
- Dirty Engine (Exterior)
- Loose Fan Drive Belt
- Radiator Shut Opening Closed
- Temperature Sensor Faulty

Correction

Add Coolant. Refer to Section

Continued





Troubleshooting and Repair Manual
ISB, ISBe4, QSB4.5, QSB5.9, QSB6.7, ISC, QSC8.3, ISL,
ISLe3 and QSL9 Engines, CM850 Electronic Control
System
Volume 1

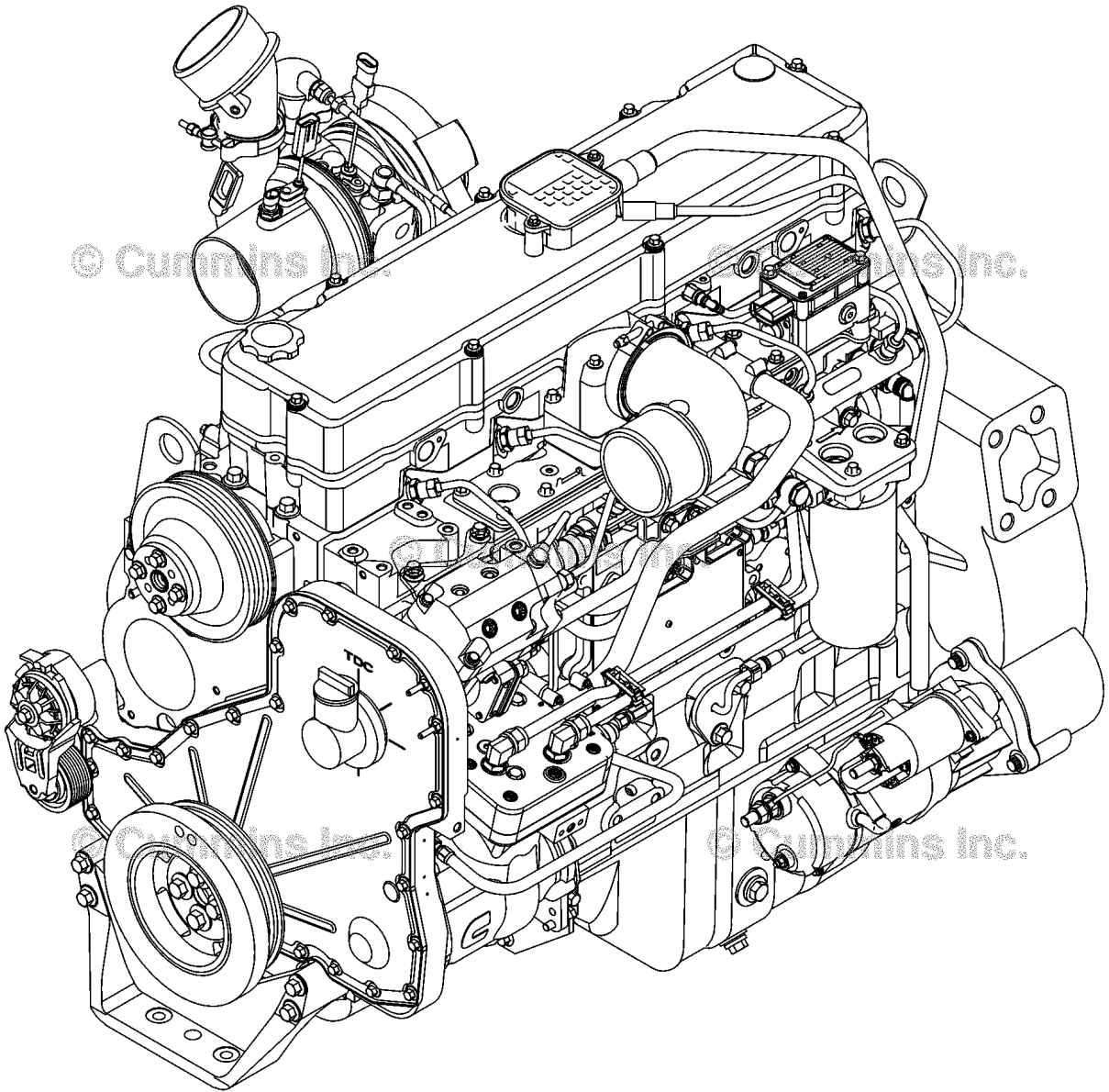

Foreword

This manual provides instructions for troubleshooting and repairing this engine in the chassis. Component and assembly rebuild procedures are provided in the engine shop manual. Refer to Section i - Introduction for instructions on how to use this manual.

Read and follow all safety instructions. Refer to the WARNING in the General Safety Instructions in Section i - Introduction.

The manual is organized to guide a service technician through the logical steps of identifying and correcting problems related to the engine. This manual does not cover vehicle or equipment problems. Consult the vehicle or equipment manufacturer for repair procedures.

A series of specific service manuals (for example: Shop, Specifications, and Alternative Repair) are available and can be ordered by Contacting your local area Cummins Regional office. A Cummins Regional office listing is located in Service Literature (Section L).

The repair procedures used in this manual are recommended by Cummins Inc. Some service procedures require the use of special service tools. Use the correct tools as described.

Cummins Inc. encourages the user of this manual to report errors, omissions, and recommendations for improvement. Please use the postage paid, pre-addressed Literature Survey Form in the back of this manual for communicating your comments.

The specifications and rebuild information in this manual are based on the information in effect at the time of printing. Cummins Inc. reserves the right to make any changes at any time without obligation. If differences are found between your engine and the information in this manual, contact a Cummins Authorized Repair Location or call 1-800-DIESELS (1-800-343-7357) toll free in the U.S. and Canada.

The latest technology and the highest quality components are used to manufacture Cummins engines. When replacement parts are needed, we recommend using only genuine Cummins or ReCon® exchange parts. These parts can be identified by the following trademarks:



Table of Contents

	Section
Introduction	i
Engine and System Identification	E
Familiarization	F
Automotive Features	FA
Industrial Features	FB
Power Generation Features	FC
Troubleshooting Fault Codes (FC0001 - FC148)	TF
Troubleshooting Symptoms	TS
Engine Performance Features	TT
Electronic Engine controls	19
Service Literature	L
Specifications	V



Section i - Introduction

Section Contents

	Page
About the Manual	i-1
General Information.....	i-1
Acronyms and Abbreviations	i-12
General Information.....	i-12
General Cleaning Instructions	i-8
Abrasive Pads and Abrasive Paper.....	i-8
Definition of Clean.....	i-8
Gasket Surfaces.....	i-9
Plastic Bead Cleaning.....	i-10
Solvent and Acid Cleaning.....	i-9
Steam Cleaning.....	i-10
General Repair Instructions	i-7
General Information.....	i-7
Welding on a Vehicle with an Electronic Controlled Fuel System.....	i-7
General Safety Instructions	i-5
Important Safety Notice.....	i-5
How to Use the Manual	i-2
General Information.....	i-2
Illustrations	i-4
General Information.....	i-4
Symbols	i-3
General Information.....	i-3

About the Manual

General Information

This Troubleshooting and Repair Manual is intended to aid in determining the cause of engine related problems and to provide recommended repair procedures.

The manual is divided into sections. Each section is equivalent to a group used in Cummins' filmcard system. Some sections contain **reference** numbers and **procedure** numbers. **Reference** numbers provide general information, specifications, diagrams, and service tools where applicable. **Procedure** numbers are used to identify and reference specific repair procedures for correcting the problem.

This manual **does not** contain fuel systems electronic troubleshooting. Use the troubleshooting trees in this manual, if there are no electronic fault codes.

This manual is designed so the troubleshooting trees are used to locate the cause of an engine problem. The troubleshooting trees then direct the user to the correct repair procedure. The repair procedures within a section are in numerical order. However, the repair steps within a given procedure are organized in the order the repair **must** be performed regardless of the numerical order of the steps. The user **must** use the contents pages or the index at the back of the manual to locate specific topics when not using the troubleshooting trees.

How to Use the Manual

General Information













This manual is organized to provide an easy flow from problem identification to problem correction. A list of troubleshooting symptoms containing the most common engine problems is in the Troubleshooting Symptoms, Section (TS). The manual is designed to use the Troubleshooting Symptoms as a guide to locating the problem and directing the end user to the correct procedure for making the repair. Complete the following steps to locate and correct the problem.

- (Step 1) Locate the symptom on the Section Contents pages of Section TS.
Reference to the page number where the Troubleshooting Symptom Tree is found is made to the right of the symptom tree title.
- (Step 2) The left column of boxes in the Troubleshooting Symptom Charts indicates a probable cause of the problem, starting at the top with the simplest and easiest to repair, and continuing downward to the most difficult.
The right column of boxes provides a brief description of the corrective action with a reference number to the correct procedure used to make the repair.
- (Step 3) Locate the probable cause in the left column then turn to the procedure referenced in the right column.
- (Step 4) The Troubleshooting Symptom Charts are based on the following assumptions:
- The engine has been installed according to the manufacturer's specifications.
 - The easiest repairs are done first.
 - "Generic" solutions to cover problems with the most common applications and Original Equipment Manufacturer (OEM).

Symbols

General Information

The following symbols have been used in this manual to help communicate the intent of the instructions. When one of the symbols appears, it conveys the meaning defined below:

	WARNING - Serious personal injury or extensive property damage can result if the warning instructions are not followed.		PERFORM a mechanical or time MEASUREMENT .
	CAUTION - Minor personal injury can result or a part, an assembly, or the engine can be damaged if the caution instructions are not followed.		LUBRICATE the part or assembly.
	Indicates a REMOVAL or DISASSEMBLY step.		Indicates that a WRENCH or TOOL SIZE will be given.
	Indicates an INSTALLATION or ASSEMBLY step.		TIGHTEN to a specific torque.
	INSPECTION is required.		PERFORM an electrical MEASUREMENT .
	CLEAN the part or assembly.		Refer to another location in this manual or another publication for additional information.
			The component weighs 23 kg [50 lb] or more. To avoid personal injury, use a hoist or get assistance to lift the component.

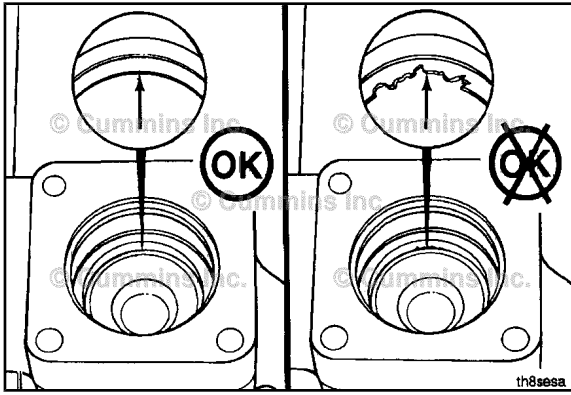

Illustrations

General Information

Some of the illustrations throughout this manual are generic and will **not** look exactly like the engine or parts used in your application. The illustrations can contain symbols to indicate an action required and an acceptable or **not** acceptable condition.

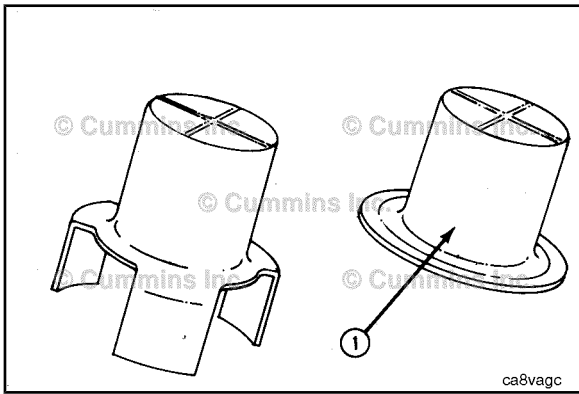

The illustrations are intended to show repair or replacement procedures. The procedure will be the same for all applications, although the illustration can differ.

General Safety Instructions

Important Safety Notice



Improper practices, carelessness, or ignoring the warnings can cause burns, cuts, mutilation, asphyxiation or other personal injury or death.

Read and understand all of the safety precautions and warnings before performing any repair. This list contains the general safety precautions that **must** be followed to provide personal safety. Special safety precautions are included in the procedures when they apply.

- Work in an area surrounding the product that is dry, well lit, ventilated, free from clutter, loose tools, parts, ignition sources and hazardous substances. Be aware of hazardous conditions that can exist.
- **Always** wear protective glasses and protective shoes when working.
- Rotating parts can cause cuts, mutilation or strangulation.
- Do **not** wear loose-fitting or torn clothing. Remove all jewelry when working.
- Disconnect the battery (negative [-] cable first) and discharge any capacitors before beginning any repair work. Disconnect the air starting motor if equipped to prevent accidental engine starting. Put a "Do **Not** Operate" tag in the operator's compartment or on the controls.
- Use **ONLY** the proper engine barring techniques for manually rotating the engine. Do **not** attempt to rotate the crankshaft by pulling or prying on the fan. This practice can cause serious personal injury, property damage, or damage to the fan blade(s) causing premature fan failure.
- If an engine has been operating and the coolant is hot, allow the engine to cool before slowly loosening the filler cap to relieve the pressure from the cooling system.
- **Always** use blocks or proper stands to support the product before performing any service work. Do **not** work on anything that is supported **ONLY** by lifting jacks or a hoist.
- Relieve all pressure in the air, oil, fuel, and cooling systems before any lines, fittings, or related items are removed or disconnected. Be alert for possible pressure when disconnecting any device from a system that utilizes pressure. Do **not** check for pressure leaks with your hand. High pressure oil or fuel can cause personal injury.
- To reduce the possibility of suffocation and frostbite, wear protective clothing and **ONLY** disconnect liquid refrigerant (Freon) lines in a well ventilated area. To protect the environment, liquid refrigerant systems **must** be properly emptied and filled using equipment that prevents the release of refrigerant gas (fluorocarbons) into the atmosphere. Federal law requires capturing and recycling refrigerant.
- To reduce the possibility of personal injury, use a hoist or get assistance when lifting components that weigh 23 kg [50 lb] or more. Make sure all lifting devices such as chains, hooks, or slings are in good condition and are of the correct capacity. Make sure hooks are positioned correctly. **Always** use a spreader bar when necessary. The lifting hooks **must not** be side-loaded.
- Corrosion inhibitor, a component of SCA and lubricating oil, contains alkali. Do **not** get the substance in eyes. Avoid prolonged or repeated contact with skin. Do **not** swallow internally. In case of contact, immediately wash skin with soap and water. In case of contact, immediately flood eyes with large amounts of water for a minimum of 15 minutes. **IMMEDIATELY CALL A PHYSICIAN. KEEP OUT OF REACH OF CHILDREN.**
- Naptha and Methyl Ethyl Ketone (MEK) are flammable materials and **must** be used with caution. Follow the manufacturer's instructions to provide complete safety when using these materials. **KEEP OUT OF REACH OF CHILDREN.**
- To reduce the possibility of burns, be alert for hot parts on products that have just been turned off, and hot fluids in lines, tubes, and compartments.
- **Always** use tools that are in good condition. Make sure you understand how to use the tools before performing any service work. Use **ONLY** genuine Cummins or Cummins ReCon® replacement parts.
- **Always** use the same fastener part number (or equivalent) when replacing fasteners. Do **not** use a fastener of lesser quality if replacements are necessary.
- Do **not** perform any repair when fatigued or after consuming alcohol or drugs that can impair your functioning.
- Some state and federal agencies in the United States of America have determined that used engine oil can be carcinogenic and can cause reproductive toxicity. Avoid inhalation of vapors, ingestion, and prolonged contact with used engine oil.
- Liquefied petroleum gas is heavier than air and can accumulate near the floor, in sumps, and low-lying areas.
- Natural gas is lighter than air and can accumulate under hood and awnings.
- To reduce the possibility of suffocation and frostbite, wear protective clothing and **ONLY** disconnect natural gas and liquefied petroleum gas lines in a well ventilated area.
- Coolant is toxic. If **not** reused, dispose of in accordance with local environmental regulations.
- The catalyst reagent contains urea. Do not get the substance in your eyes. In Case of contact, immediately flood eyes with large amounts of water for a minimum of 15 minutes. Avoid prolonged contact with skin. In case of contact, immediately wash skin with soap and water. Do not swallow internally. In the event the catalyst reagent is ingested, contact a physician immediately.

- The catalyst substrate contains Vanadium Pentoxide. Vanadium Pentoxide has been determined by the State of California to cause cancer. Always wear protective gloves and eye protection when handling the catalyst assembly. Do not get the catalyst material in your eyes. In Case of contact, immediately flood eyes with large amounts of water for a minimum of 15 minutes. Avoid prolonged contact with skin. In case of contact, immediately wash skin with soap and water.
- The Catalyst substrate contains Vanadium Pentoxide. Vanadium Pentoxide has been determined by the State of California to cause cancer. In the event the catalyst is being replaced, dispose of in accordance with local regulations.

General Repair Instructions

General Information

This engine incorporates the latest technology at the time it was manufactured; yet, it is designed to be repaired using normal repair practices performed to quality standards.

- **Cummins Inc. does not recommend or authorize any modifications or repairs to engines or components except for those detailed in Cummins Service Information. In particular, unauthorized repair to safety-related components can cause personal injury or death. Below is a partial listing of components classified as safety-related:**

- | | |
|---------------------------------|---|
| 1. Air Compressor | 12. Flywheel Mounting Capscrews |
| 2. Air Controls | 13. Fuel Shutoff Assemblies |
| 3. Air Shutoff Assemblies | 14. Fuel Supply Tubes |
| 4. Balance Weights | 15. Lifting Brackets |
| 5. Cooling Fan | 16. Throttle Controls |
| 6. Fan Hub Assembly | 17. Turbocharger Compressor Casing |
| 7. Fan Mounting Bracket(s) | 18. Turbocharger Oil Drain Line(s) |
| 8. Fan Mounting Capscrews | 19. Turbocharger Oil Supply Line(s) |
| 9. Fan Hub Spindle | 20. Turbocharger Turbine Casing |
| 10. Flywheel | 21. Vibration Damper Mounting Capscrews |
| 11. Flywheel Crankshaft Adapter | |

- **Follow all safety instructions noted in the procedures**
 - Follow the manufacturer's recommendations for cleaning solvents and other substances used during the repair of the engine. Some solvents and used engine oil have been identified by government agencies as toxic or carcinogenic. Avoid excessive breathing, ingestion and contact with such substances. **Always** use good safety practices with tools and equipment.
- **Provide a clean environment and follow the cleaning instructions specified in the procedures**
 - The engine and its components **must** be kept clean during any repair. Contamination of the engine or components will cause premature wear.
- **Perform the inspections specified in the procedures**
- **Replace all components or assemblies which are damaged or worn beyond the specifications**
- **Use genuine Cummins new or ReCon® service parts and assemblies**
 - The assembly instructions have been written to use again as many components and assemblies as possible. When it is necessary to replace a component or assembly, the procedure is based on the use of new Cummins or Cummins ReCon® components. All of the repair services described in this manual are available from all Cummins Distributors and most Dealer locations.
- **Follow the specified disassembly and assembly procedures to reduce the possibility of damage to the components**

Complete rebuild instructions are available in the shop manual which can be ordered or purchased from a Cummins Authorized Repair Location. Refer to Section L — Service Literature for ordering instructions.

Welding on a Vehicle with an Electronic Controlled Fuel System



Disconnect both the positive (+) and negative (-) battery cables from the battery before welding on the vehicle. Attach the welder ground cable no more than 0.61 meters [2 feet] from the part being welded. Do not connect the ground cable of the welder to the ECM cooling plate or ECM. Welding on the engine or engine mounted components is not recommended or damage to the engine or components can result.

General Cleaning Instructions

Definition of Clean

Parts **must** be free of debris that can contaminate any engine system. This does **not** necessarily mean they have to appear as new.

Sanding gasket surfaces until the factory machining marks are disturbed adds no value and is often harmful to forming a seal. It is important to maintain surface finish and flatness tolerances to form a quality sealing surface. Gaskets are designed to fill small voids in the specified surface finish.

Sanding gasket surfaces where edge-molded gaskets are used is most often unnecessary. Edge-molded gaskets are those metal carriers with sealing material bonded to the edges of the gasket to seal while the metal portion forms a metal to metal joint for stability. Any of the small amounts of sealing material that can stick to the parts are better removed with a blunt-edged scraper on the spots rather than spending time polishing the whole surface with an air sander or disc.

For those gaskets that do **not** have the edge molding, nearly all have a material that contains release agents to prevent sticking. Certainly this is **not** to say that some gaskets are **not** difficult to remove because the gasket has been in place a long time, has been overheated or the purpose of the release agent has been defeated by the application of some sealant. The object however is just to remove the gasket without damaging the surfaces of the mating parts without contaminating the engine (don't let the little bits fall where they can not be removed).

Bead blasting piston crowns until the dark stain is removed is unnecessary. All that is required is to remove the carbon build-up above the top ring and in the ring grooves. There is more information on bead blasting and piston cleaning later in this document.

Cummins Inc. does **not** recommend sanding or grinding the carbon ring at the top of cylinder liners until clean metal is visible. The liner will be ruined and any signs of a problem at the top ring reversal point (like a dust-out) will be destroyed. It is necessary to remove the carbon ring to provide for easier removal of the piston assembly. A medium bristle, high quality, steel wire wheel that is rated above the rpm of the power tool being used will be just as quick and there will be less damage. Yes, one **must** look carefully for broken wires after the piston is removed but the wires are more visible and can be attracted by a magnet.

Oil on parts that have been removed from the engine will attract dirt in the air. The dirt will adhere to the oil. If possible, leave the old oil on the part until it is ready to be cleaned, inspected and installed, and then clean it off along with any attracted dirt. If the part is cleaned then left exposed it can have to be cleaned again before installation. Make sure parts are lubricated with clean oil before installation. They do **not** need to be oiled all over but do need oil between moving parts (or a good lube system priming process conducted before cranking the engine).

Bead blasting parts to remove exterior paint is also usually unnecessary. The part will most likely be painted again so all that needs happen is remove any loose paint.

Abrasive Pads and Abrasive Paper

The keyword here is "abrasive". There is no part of an engine designed to withstand abrasion. That is they are all supposed to lock together or slide across each other. Abrasives and dirt particles will degrade both functions.



Abrasive material must be kept out of or removed from oil passages and parts wear points. Abrasive material in oil passages can cause bearing and bushing failures that can progress to major component damage beyond reuse. This is particularly true of main and rod bearings.

Cummins Inc. does **not** recommend the use of emery cloth or sand paper on any part of an **assembled** engine or component including but **not** limited to removing the carbon ridge from cylinder liners or to clean block decks or counterbores.

Great care **must** be taken when using abrasive products to clean engine parts, particularly on partially assembled engines. Abrasive cleaning products come in many forms and sizes. All of them contain aluminum oxide particles, silicon carbide, or sand or some other similar hard material. These particles are harder than most of the parts in the engine. Since they are harder, if they are pressed against softer material they will either damage the material or become embedded in it. These materials fall off the holding media as the product is used. If the products are used with power equipment the particles are thrown about the engine. If the particles fall between two moving parts, damage to the moving parts is likely.

If particles that are smaller than the clearance between the parts while they are at rest (engine stopped), but larger than the running clearance then damage will occur when the parts move relative to each other (engine started). While the engine is running and there is oil pressure, particles that are smaller than the bearing clearance are likely to pass between the parts without damage and be trapped in the oil filter. However, particles larger than the bearing clearance will remove material from one part and can become embedded in one of the parts. Once embedded in one part it will

abrade the other part until contact is no longer being made between the two parts. If the damage sufficiently degrades the oil film, the two parts will come into contact resulting in early wear-out or failure from lack of effective lubrication.

Abrasive particles can fly about during cleaning it is **very** important to block these particles from entering the engine as much as possible. This is particularly true of lubricating oil ports and oil drilling holes, especially those located downstream of the lubricating oil filters. Plug the holes instead of trying to blow the abrasive particles and debris with compressed air because the debris is often simply blown further into the oil drilling.

All old gasket material **must** be removed from the parts gasket surfaces. However, it is **not** necessary to clean and polish the gasket surface until the machining marks are erased. Excessive sanding or buffing can damage the gasket surface. Many newer gaskets are of the edge molded type (a steel carrier with a sealing member bonded to the steel). What little sealing material that can adhere is best removed with a blunt-edged scraper or putty knife. Cleaning gasket surfaces where an edge-molded gasket is used with abrasive pads or paper is usually a waste of time.

WARNING

Excessive sanding or grinding the carbon ring from the top of the cylinder liners can damage the liner beyond reuse. The surface finish will be damaged and abrasive particles can be forced into the liner material which can cause early cylinder wear-out or piston ring failures.

Tape off or plug all openings to any component interior before using abrasive pads or wire brushes. If really necessary because of time to use a power tool with abrasive pads, tape the oil drillings closed or use plug and clean as much of the surface as possible with the tool but clean around the oil hole/opening by hand so as to prevent contamination of the drilling. Then remove the tape or plug and clean the remaining area carefully and without the tool. **DO NOT** use compressed air to blow the debris out of oil drilling on an assembled engine! More likely than **not**, the debris can be blown further into the drilling. Using compressed air is fine if both ends of the drilling are open but that is rarely the case when dealing with an assembled engine.

Gasket Surfaces

The object of cleaning gasket surfaces is to remove any gasket material, not refinish the gasket surface of the part.

Cummins Inc. does **not** recommend any specific brand of liquid gasket remover. If a liquid gasket remover is used, check the directions to make sure the material being cleaned will **not** be harmed.

Air powered gasket scrapers can save time but care must be taken to **not** damage the surface. The angled part of the scraper must be against the gasket surface to prevent the blade from digging into the surface. Using air powered gasket scrapers on parts made of soft materials takes skill and care to prevent damage.

Do **not** scrape or brush across the gasket surface if at all possible.

Solvent and Acid Cleaning

Several solvent and acid-type cleaners can be used to clean the disassembled engine parts (other than pistons. See Below). Experience has shown that the best results can be obtained using a cleaner that can be heated to 90° to 95° Celsius (180° to 200° Fahrenheit). Kerosene emulsion based cleaners have different temperature specifications, see below. A cleaning tank that provides a constant mixing and filtering of the cleaning solution will give the best results. Cummins Inc. does not recommend any specific cleaners. Always follow the cleaner manufacturer's instructions. Remove all the gasket material, o-rings, and the deposits of sludge, carbon, etc., with a wire brush or scraper before putting the parts in a cleaning tank. Be careful not to damage any gasket surfaces. When possible, steam clean the parts before putting them in the cleaning tank.

WARNING

When using solvents, acids, or alkaline materials for cleaning, follow the manufacturers recommendations for use. Wear goggles and protective clothing to reduce the possibility of personal injury.

Experience has shown that kerosene emulsion based cleaners perform the best to clean pistons. These cleaners should **not** be heated to temperature in excess of 77°C (170°F). The solution begins to break down at temperatures in excess of 82°C (180°F) and will be less effective.

Do **not** use solutions composed mainly of chlorinated hydrocarbons with cresols, phenols and/or cresylic components. They often do **not** do a good job of removing deposits from the ring groove and are costly to dispose of properly.

Solutions with a pH above approximately 9.5 will cause aluminum to turn black; therefore do **not** use high alkaline solutions.

Chemicals with a pH above 7.0 are considered alkaline and those below 7.0 are acidic. As you move further away from the neutral 7.0, the chemicals become highly alkaline or highly acidic.

Remove all the gasket material, o-rings, and the deposits of sludge, carbon, etc., with a wire brush or scraper before putting the parts in a cleaning tank. Be careful to **not** damage any gasket surfaces. When possible use hot high

pressure water or steam clean the parts before putting them in the cleaning tank. Removing the heaviest dirt before placing in the tank will allow the cleaner to work more effectively and the cleaning agent will last longer.

Rinse all the parts in hot water after cleaning. Dry completely with compressed air. Blow the rinse water from all the capscrew holes and the oil drillings.

If the parts are **not** to be used immediately after cleaning, dip them in a suitable rust proofing compound. The rust proofing compound **must** be removed from the parts before assembly or installation on the engine.

Steam Cleaning

Steam cleaning can be used to remove all types of dirt that can contaminate the cleaning tank. It is a good method for cleaning the oil drillings and coolant passages



When using a steam cleaner, wear safety glasses or a face shield, as well as protective clothing. Hot steam can cause serious personal injury.

Do **not** steam clean the following components:

- Electrical Components
- Wiring Harnesses
- Injectors
- Fuel Pump
- Belts and Hoses
- Bearings (ball or taper roller)
- Electronic Control Module (ECM)
- ECM Connectors
- Dosing Control Unit

Plastic Bead Cleaning

Cummins Inc. does **not** recommend the use of glass bead blast or walnut shell media on **any** engine part. Cummins Inc. recommends using **only** plastic bead media, Part Number 3822735 or equivalent on any engine part. **Never** use sand as a blast media to clean engine parts. Glass and walnut shell media when **not** used to the media manufacturer's recommendations can cause excess dust and can embed in engine parts that can result in premature failure of components through abrasive wear.

Plastic bead cleaning can be used on many engine components to remove carbon deposits. The cleaning process is controlled by the use of plastic beads, the operating pressure and cleaning time.



Do not use bead blasting cleaning methods on aluminum pistons skirts or the pin bores in any piston, piston skirt or piston crown. Small particles of the media will embed in the aluminum or other soft metal and result in premature wear of the cylinder liner, piston rings, pins and pin bores. Valves, turbocharger shafts, etc., can also be damaged. Follow the cleaning directions listed in the procedures.



Do not contaminate wash tanks and tank type solvent cleaners with the foreign material and plastic beads. Remove the foreign material and plastic beads with compressed air, hot high pressure water or steam before placing them in tanks or cleaners. The foreign material and plastic beads can contaminate the tank and any other engine parts cleaned in the tank. Contaminated parts may cause failures from abrasive wear.

Plastic bead blasting media, Part Number 3822735, can be used to clean all piston ring grooves. Do **not** use any bead blasting media on piston pin bores or aluminum skirts.

Follow the equipment manufacturer's cleaning instructions. Make sure to adjust the air pressure in the blasting machine to the bead manufacturer's recommendations. Turning up the pressure can move material on the part and cause the plastic bead media to wear out more quickly. The following guidelines can be used to adapt to manufacturer's instructions:

1. Bead size: U.S. size Number 16 — 20 for piston cleaning with plastic bead media, Part Number 3822735
2. Operating Pressure — 270 kPa (40 psd) for piston cleaning. Pressure should not cause beads to break.
3. Steam clean or wash the parts with solvent to remove all of the foreign material and plastic beads after cleaning. Rinse with hot water. Dry with compressed air.



The bead blasting operation must not disturb the metal surface. If the metal surface is disturbed the engine can be damaged due to increased parts clearance or inadequate surface finish on parts that move against other parts.

When cleaning pistons, it is **not** necessary to remove all the dark stain from the piston. All that is necessary is to remove the carbon on the rim and in the ring grooves. This is best done by directing the blast across the part as opposed to straight at the part. If the machining marks are disturbed by the blasting process, then the pressure is too high or the blast is being held on one spot too long. The blast operation **must not** disturb the metal surface.

Walnut shell bead blast material is sometimes used to clean ferrous metals (iron and steel). Walnut shell blasting produces a great amount of dust particularly when the pressure if the air pressure on the blasting machine is increased above media manufacturer's recommendation. Cummins Inc. recommends **not** using walnut shell media to clean engine parts due to the risk media embedment and subsequent contamination of the engine.

Cummins Inc. now recommends glass bead media **NOT** used to clean any engine parts. Glass media is too easily embedded into the material particularly in soft materials and when air pressures greater than media manufacturer's recommend are used. The glass is an abrasive so when it is in a moving part, that part is abrading all the parts in contact with it. When higher pressures are used the media is broken and forms a dust of a very small size that floats easily in the air. This dust is very hard to control in the shop, particularly if **only** compressed air (and not hot water) is used to blow the media after it is removed from the blasting cabinet (blowing the part off inside the cabinet may remove large accumulations but never removes all the media).

Bead blasting is best used on stubborn dirt/carbon build-up that has **not** been removed by first steam/higher pressure washing then washing in a heated wash tank. This is particularly true of pistons. Steam and soak the pistons first then use the plastic bead method to safely remove the carbon remaining in the grooves (instead of running the risk of damaging the surface finish of the groove with a wire wheel or end of a broken piston ring. Make sure the parts are dry and oil free before bead blasting to prevent clogging the return on the blasting machine.

Always direct the bead blaster nozzle "across" rather than directly at the part. This allows the bead to get under the unwanted material. Keep the nozzle moving rather than hold on one place. Keeping the nozzle directed at one-place too long causes the metal to heat up and be moved around. Remember that the spray is **not** just hitting the dirt or carbon. If the machining marks on the piston groove or rim have been disturbed then there has **not** been enough movement of the nozzle and/or the air pressure is too high.

Never bead blast valve stems. Tape or use a sleeve to protect the stems during bead blasting. Direct the nozzle across the seat surface and radius rather than straight at them. The object is to remove any carbon build up and continuing to blast to remove the stain is a waste of time.

**Thank you very much for
your reading. Please Click
Here. Then Get COMPLETE
MANUAL. NO WAITING**



NOTE:

**If there is no response to
click on the link above,
please download the PDF
document first and then
click on it.**

Acronyms and Abbreviations

General Information

The following list contains some of the acronyms and abbreviations used in this manual.

API	American Petroleum Institute
ASTM	American Society of Testing and Materials
°C	Celsius
CARB	California Air Resources Board
C.I.D.	Cubic Inch Displacement
CNG	Compressed Natural Gas
CPL	Control Parts List
cSt	Centistokes
ECM	Electronic Control Module
EGR	Exhaust Gas Recirculation
EPA	Environmental Protection Agency
°F	Fahrenheit
FMI	Failure Mode Identifier
GVW	Gross Vehicle Weight
LPG	Liquified Petroleum Gas
Hg	Mercury
hp	Horsepower
H₂O	Water
ICM	Ignition Control Module
km/l	Kilometers per Liter
kPa	Kilopascal
LNG	Liquid Natural Gas
LTA	Low Temperature Aftercooling
MPa	Megapascal
mph	Miles Per Hour
mpq	Miles Per Quart
N•m	Newton-meter
NG	Natural Gas
OEM	Original Equipment Manufacturer
PID	Parameter Identification Descriptions
ppm	Parts Per Million
psi	Pounds Per Square Inch
PTO	Power Takeoff
rpm	Revolutions Per Minute
SAE	Society of Automotive Engineers
SCA	Supplemental Coolant Additive
STC	Step Timing Control
SID	Subsystem Identification Descriptions
VS	Variable Speed
VSS	Vehicle Speed Sensor

Section E - Engine and System Identification

Section Contents

	Page
Engine Diagrams	E-3
Engine Views.....	E-3
With CM850.....	E-3
ISB.....	E-8
Marine Applications.....	E-13
Engine Identification	E-1
ECM Dataplate.....	E-2
Engine Dataplate.....	E-1